



ALUMINIUM GREENHOUSE

Riga S / Riga

Subject to technical changes!

Current as of 09/2015

Basic kit assembly instructions



model Riga S
system width 2,32 m / 7ft 8in

model Riga
system width 2,96 m / 9ft 8in



Dear garden friend,

Congratulations on the purchase of an aluminium greenhouse made by



The construction is simple. First, read all the assembly instructions then follow them step by step.

Parts and parts list

Please store all boxes in a dry area protected from direct sunlight!

Quantity of cartons

	basic construction (gable/eaves)	curved center profile	windows/ doors	glazing
Riga S/II/III/IV	1	1	1	1
Riga III/IV/V	1	1	1	1

Start with the box labeled "basic kit". Please do not open all the boxes at the same time. This will prevent confusing the parts.

Before you begin assembly of a section check the parts list for that box and make sure all parts are present. Parts lists are provided in every box. The boxes go through a quality check before they are closed, thus missing parts are rare. Should any parts be missing please call the customer service number below.

Customer Service: 877-760-8500 or 512-407-8500 sales@Exaco.com
Exaco Trading
10203 Metropolitan Dr.
Austin, TX 78758

Location

Choose, if possible, a sunny place for your greenhouse. Avoid the shadows of buildings and trees. For vegetables, like tomatoes, cucumbers and melons, position your greenhouse the most north-south as possible. For flowers and potted plant , position in the east-west-direction.

Warning:

The greenhouse should preferably be built in a sheltered spot and not during stormy weather. It is dangerous to leave a partly assembled house!

If assembled correctly this greenhouse resists strong winds. The manufacturer assumes no responsibility for any damage by improper installation or acts of nature.

The construction of the greenhouse must be conducted by at least two people. Work with secure, craft-oriented tools. Be careful when assembling and make sure your ladder is secure.

In principle work only with gloves (risk of injury, average risk!).

For the configuration you need the following tools:

- 1 pc. Phillips screwdriver size 2
- 1 pc. 10mm Wrench
- 1 pc. 3mm allen key (included in the accessoires bag of the roof window)
- 1 pc. level
- 1 pc. stepladder
- 1 pc. file to remove any burrs on the profil
- 1 pc. rubber hammer
- 1 pc. tape measure

You should be careful:

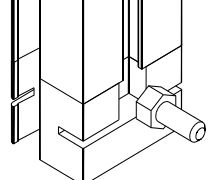
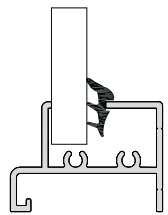
	<p>Wedge seals (V23) Pull them apart at the center.</p>		<p>If forgotten, hexagonal screws can also be inserted later in the plastic slider! The plastic slider is located in the bottom of the door frame, side and roof bars.</p>
	<p>Push the seal 3 - 5 mm between the soil profile and the glazing Both inside the greenhouse!</p> <p>Important: Compress the seals when you install them as they contract in cold weather</p>		

Quantity of wedge seals

	3 - 5 mm	3 - 5 mm	6 - 8 mm
length	712 mm	768 mm	1030 mm
model	712 mm	768 mm	1030 mm
Riga S II	4	1	7
Riga S III	4	1	11
Riga S IV	4	1	14

	3 - 5 mm	3 - 5 mm	6 - 8 mm
length	768 mm	1030 mm	1030 mm
model	768 mm	1030 mm	1030 mm
Riga III	1	4	11
Riga IV	1	4	14
Riga V	1	4	16

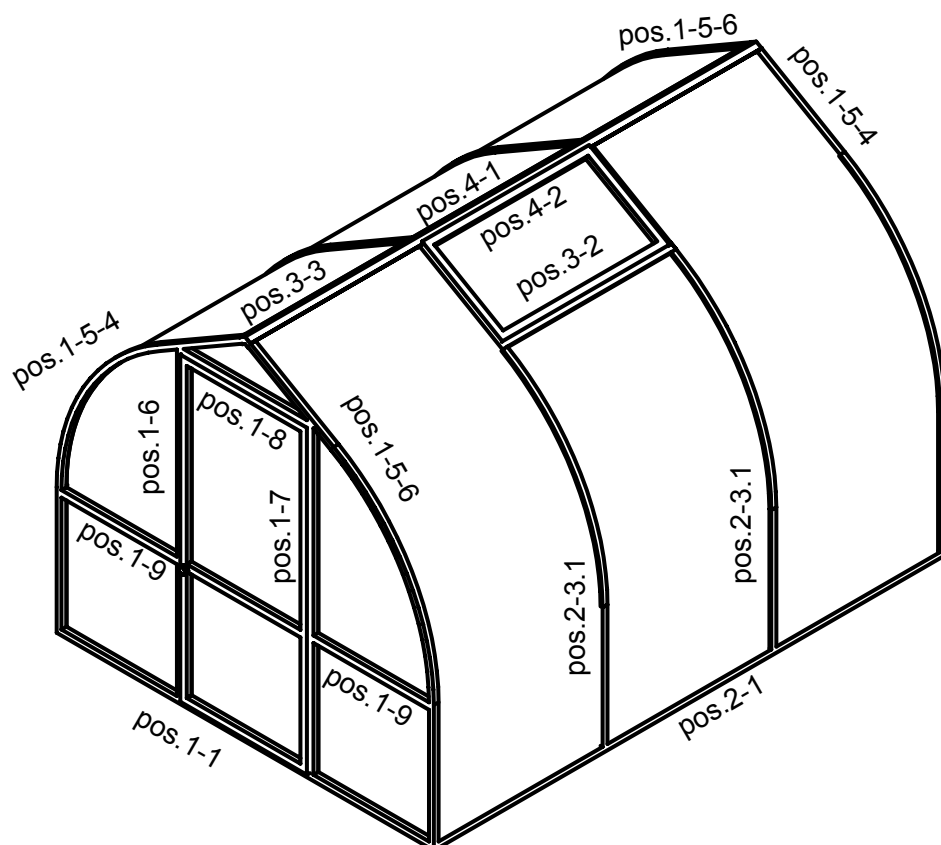

!!!Note: Important information for glazing!!!

When installing the polycarbonate glazing make sure the UV coated side faces out. Loosen the edges of the protective film for installation. After the assembly is complete pull it off immediately. Do not leave the film on for any period of time in the sunlight. Several days of sunlight can burn the film firmly on the glazing.

Do not pull the film off right out of the box, otherwise you cannot tell which side has the UV protection!

Suggestion: If you plan on disassembling and moving you should mark the UV side of each panel before installation. A small circle in a lower corner with a permanent marker will work well.

Question: Does the greenhouse glazing need to be completely sealed?

In principle: **No**.

We recommend that you seal the horizontal transitions where the glazing meets the aluminum profiles with a neutral cure transparent silicone. (Shown in the diagram below by dashed lines.) This will prevent water and dirt from entering the glazing slots.

Advantage: The greenhouse stays looking new as the seal prevents the formation of algae and buildup of dirt/dust inside the glazing.

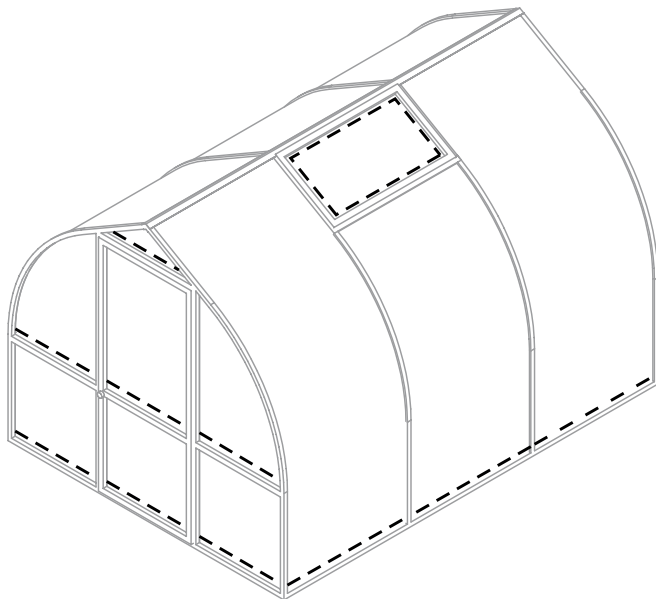

During some weather conditions condensation can occur within the hollow chambers of the glazing. This is because the glazing chambers are not air tight. The condensation is purely aesthetic and cannot be avoided. The condensation/water vapor will not damage the glazing, even at freezing temperatures.

Warning: Use only neutral cure silicone, otherwise it may lead to stress cracks in plastic glazing. This is the most common silicone sealant.

Neutral cure silicone is available in most hardware stores. We recommend Boss 399. You can purchased Boss 399 directly from us, just call 1-877-760-8500.

Cleaning and care:

To wash the greenhouse use plenty of water, a car wash brush and a little detergent.

Foundation frame (optional)

!!!Warning: Use only according to instructions. See below!!!

This is the easiest and the safest foundation for a greenhouse.

ATTENTION! When using a foundation frame attach it to the soil profile before these steps (see pages 5, 6)

The foundation frame hooks into the soil profile and the corners are bolted together with a corner angle (V26). (See page 6). Use the supplied self tapping screws to firmly attach the soil profile to the foundation frame.

Setting up the foundation frame

Dig a small ditch 4-5 inches deep in the dimensions of the foundation frame.

Use paving stones or gravel under the horizontal sections as much as possible to prevent the potential for the greenhouse to sag. Fill in the rest of the ditch with earth.

It is also very practical to install tile or stone flooring, this prevents the mud from splashing on the greenhouse during heavy rain.

In addition it makes work easier around the greenhouse, such as mowing the lawn.

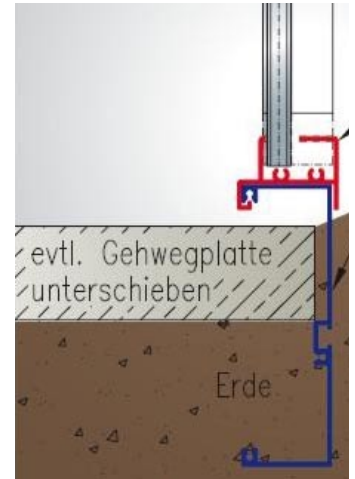

Profiles and accessories for foundation frame *Riga S*:

- See next page!

overview	pos.	description	number/length in mm		
			type II	type III	type IV
	6.1	foundation frame profile gable #	2 2199	2 2199	2 2199
	6.2	foundation frame profile eaves #	2 2033	2 3091	2 4149
	V26	foundation frame corner bracket 40/40/2 x 105 item no 9999 0078	4 105	4 105	4 105
	V27	mounting bracket (rung/foundation frame) item no 9999 0267	10 135	10 135	10 135
	S12 S1	hexagonal screw M6 x 12 + nut M6 item no 9999 0124 + 9999 0128	20	20	20

Profiles and accessories for foundation frame *Riga*: (V26/V27/S12/S1 as above)

overview	pos.	description	number/length in mm		
			type III	type IV	type V
	6.1	foundation frame profile gable	2 2835	2 2835	2 2835
	6.2	foundation frame profile eaves	2 3091	2 4149	2 5207

Assembly foundation frame

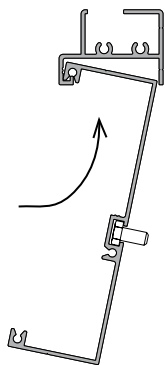

Rotate the foundation frame profile into the soil profile. Make sure it is centered in the soil profile.
Note: The foundation frame profiles are shorter than soil profiles

Note: The foundation frame profiles are shorter than soil profiles



In the foundation frame corners use two M6 x 12 bolts (S12) and one corner bracket (V26) Fasten them with two M6 nuts (S1).

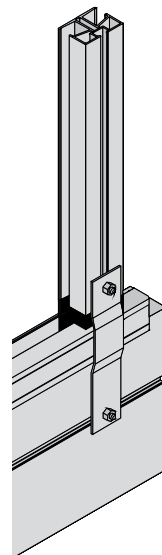

To stabilize the greenhouse, use the mounting bracket (V27) with bolts M6 x 12 (S12) Bolt the (V27) to the foundation frame and the side curves or door frames. Use the supplied self tapping screws to firmly attach the soil profile to the foundation frame.

Foundation of the greenhouse

We recommend that you use anchor bolts to secure the soil profile to your foundation. to The anchor bolts are **not** included.

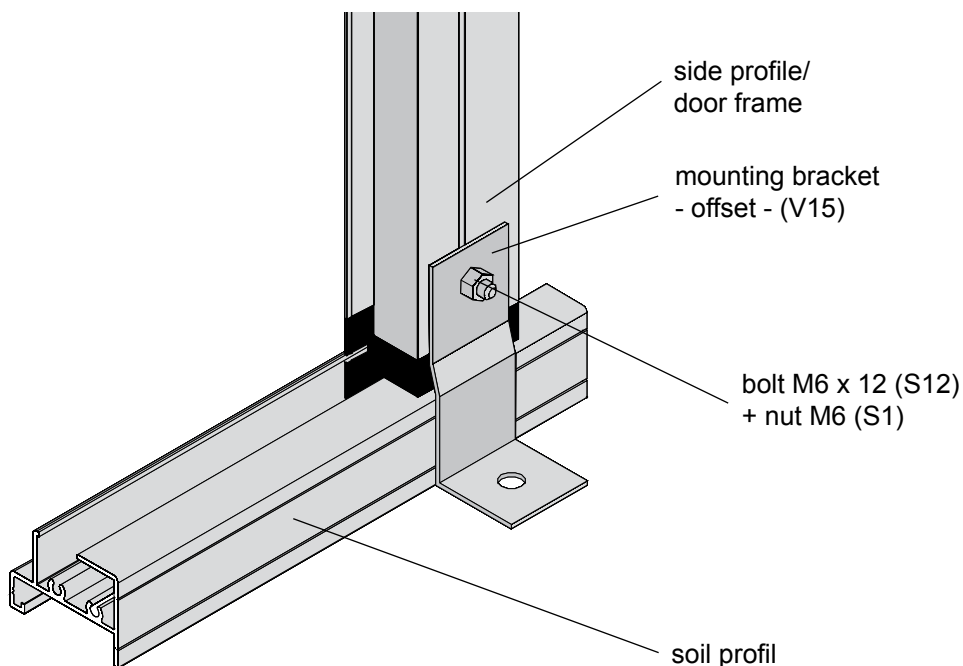



Foundation plan Riga S/Riga

all dimensions in [cm]

Foundation of your greenhouse with a strip foundation

If you have not purchased a foundation frame secure the greenhouse by means of a strip foundation. Create the foundation in accordance with the specified dimensions below.

Creating a stone/cement base is not required. The greenhouse can be placed directly on the ground.

Concrete masonry units are also a good choice

Please make sure that the foundation is level in all directions.

Then anchor the greenhouse with the included mounting brackets (V15)(minimum) Screws and anchors are **not** included.

(Option) Opening for Door Drop Kit: ; ; ; ^m

Suggestion: Assemble the lower frame (soil profiles 1.1/2.1, soil profile corner V9) of the greenhouse to use as a template to create a stone or concrete foundation. Make sure the corners are square. This will prevent any errors in measurement.

Centimeters divided by 2.54 = inches For instance 233cm/2.54=91.7in

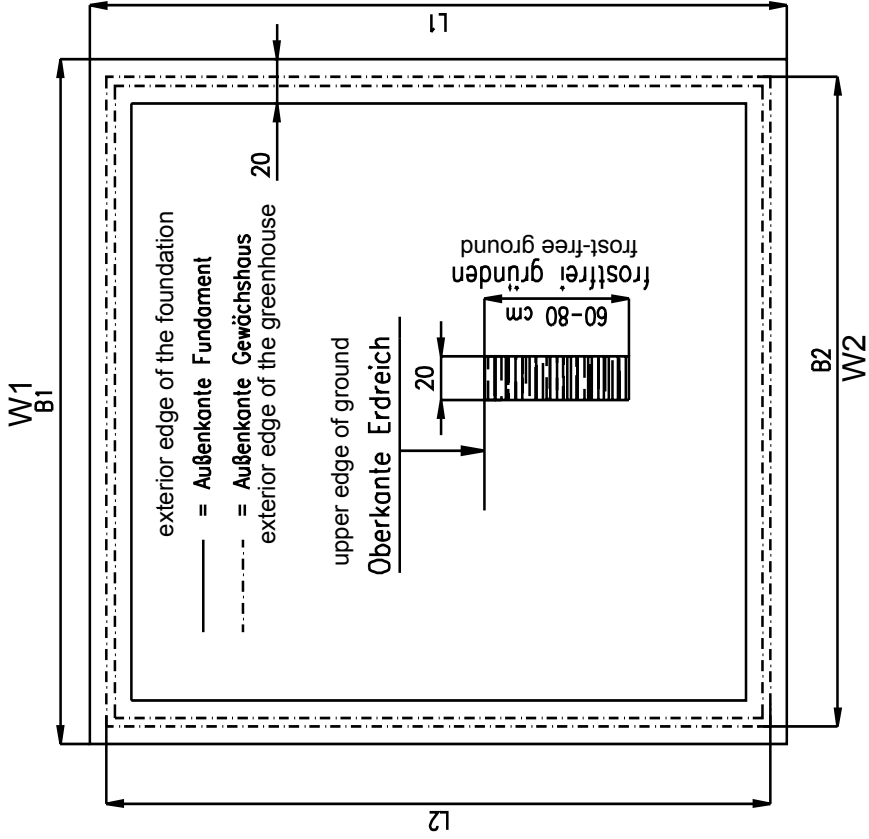

model	foundation		greenhouse	
	W1	L1	W2	L2
Riga S II	249	232	233	216
Riga S III	249	338	233	322
Riga S IV	249	443	233	427
Riga III	312	338	296	322
Riga IV	312	443	296	427
Riga V	312	549	296	533



Main box Contents - basic kit Riga S/Riga

Please check contents list to make sure all items are there

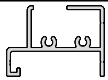
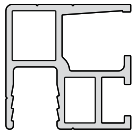
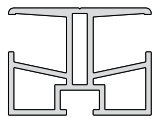
Profiles for both gables:

overview	pos.	description	number/length in mm					
			Riga S			Riga		
			II	III	IV	III	IV	V
	1.1	soil profile/gable	2 2238	2 2238	2 2238	2 2874	2 2874	2 2874
	1.5.4	Edge curve left	2	2	2	2	2	2
	1.5.6	Edge curve right	2	2	2	2	2	2
	1.6	door frame left with slant	2 1876	2 1876	2 1876	2 2059	2 2059	2 2059
	1.7	door frame right with slant and holes	2 1876	2 1876	2 1876	2 2059	2 2059	2 2059
	1.8	door frame top	2 758	2 758	2 758	2 758	2 758	2 758
	1.8	cross bar in the side door without	1 758	1 758	1 758	1 758	1 758	1 758
	1.9	cross bar left and right	4 702	4 702	4 702	4 1020	4 1020	4 1020

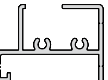
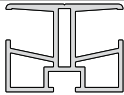
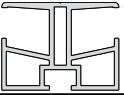
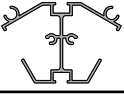
Profiles for eaves:

overview	pos.	description	number/length in mm					
			Riga S			Riga		
			II	III	IV	III	IV	V
	2.1	soil profile/eave	2 2072	2 3130	2 4188	2 3130	2 4188	2 5246
	2.3	Side curve	2	4	6	4	6	8
	3.2	cross bar/roof window	1 1020	1 1020	2 1020	1 1020	2 1020	4 1020
	3.3	ridge profil	1 2137	1 3195	1 4253	1 3195	1 4253	1 5311
	3.4	angle stabilization	4 2104	4 3162	4 4220	4 3162	4 4220	4 5278

Accessories bag basic kit Riga S/Riga

overview	pos.	description/ item number		num- ber RigaS	num- ber Riga
	V9	Soil profile corner item no 9999 0003		4	4
	V5	connecting plate item no 9999 0028	Edge Clamp/Door Frame	4	4
	V10	connecting plate 90 x 35 mm item no 9999 0030	For mounting cross bar/rear	2	2
	V11	endplate ridge/gutter item no 9999 0075		2	2
	V4	connecting plate item no 9999 0031	for cross bar/roof window	II = 2 III = 2 IV = 4	III = 2 IV = 4 V = 8
	V12	corner 30/30/2/15 mm item no 9999 0072	soil profil screw the corner from inside	4	4
	S21	blind plug Ø10 mm item no 9999 0097	Edge profile-drilling cross bar	4	4
	V14	door hose section 760 mm lg. item no 9999 0181	door threshold seal	1	1
	V23	wedge seal 3 - 5 mm item no 9999 0119	sealing the soil profile insid	See table below !	See table below!
	S9	self-tapping screw pan head 4,2x 13 item no 9999 0144	door frame-soil profile cover plate/corner (V12)	38*	38*
	S13	self-tapping screw pan head 4,8 x 45 item no 9999 0150	gable	6	6
	S5/ S1	hexagonal screw M6 x 16 + nut item no 9999 0183 + 9999 0128	screws for pulling	II = 40* III = 40* IV = 44*	III = 40* IV = 44* V = 48*
	V15	mounting bracket - offset 74 x 30 x 33 mm item no 9999 0207	for the attachment of the greenhouse to a foundation made by customer (not with foundation frame)	10	10
	S32	washer A6,4 item no 9999 0173	door frames, roof and side profiles	20	20 V = 24
	V1	mounting corner bracket inside item no 9999 00074		je 2x lks. 2x rts.	je 2x lks. 2x rts.

Assembly procedure gable

view from inside

ATTENTION! When using a foundation frame attach it to soil profile in advance (see pages 5, 6)

step 1

soil profile corner (V9)

door frame left (pos. 1.6)

door frame right (pos. 1.7)

soil profile (pos. 1.1)

to step 1:

Items needed:
 Pos 1.6 (Door frame left)
 Pos 1.7 (Door frame right with 8 holes)
 Pos 1.1 (Soil Profile)
 Soil Profile Corner (V9)
 Slide pos 1.6 and pos 1.7 up to the small holes in the middle of pos 1.1 (soil profile). The chamfered edge must be facing to the outside. Then attach the soil profile corner (V9) to the ends of the soil profile.

step 2

Riga S	Riga
730 x 728	1048 x 728

glazing

glazing

self-tapping screw pan head 4,2 x 13 (S9)

Note: Only attach after the door is mounted and aligned

to step 2:

Now you need the small side glazing. Slide the side glazing into the door frames and soil profile. The dimensions are listed in the diagram.

Note: After the door is mounted and aligned attach pos 1.6 and pos 1.7 with pan head screw 4,2 x 13 (S9).

step 3

cross bar (pos. 1.9)

cross bar (pos. 1.9)

to step 3:

Now insert the cross bar (pos. 1.9) onto the top of the glazing.

step 4

view from inside

self-tapping screw pan head 4,2 x 13 (S9)

connecting plate (V5)

door frame top (pos. 1.8)

glazing

glazing

screw M6 x 16 (S5) with nut M6 (S1)

to step 4:

Items needed:
 Two Connecting Plates (V5)
 Pos 1.8 (Cross Bar-door frame top)
 Four Hex Screws M6 x 16 (S5)
 Slide one hex screw M6 x 16 (S5) into the vertical door frames (pos 1.6/1.7) and two in the crossbar (pos 1.8)
 Attach the crossbar to the door frames with the connecting plate (V5).
 Insert the curved glazing into the door frames and cross bar (pos 1.9)

Assembly procedure gable

ATTENTION! When using a foundation frame attach it to soil profile in advance (see pages 5, 6)

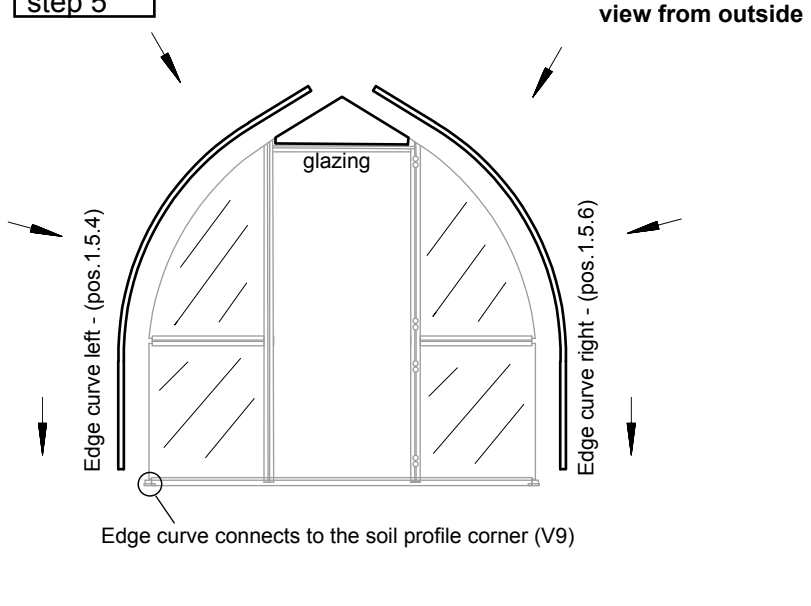
<p>step 5</p> <p>view from outside</p> 	<p>to step 5:</p> <p>The square peg in the soil profile corner (V9) is plugged into the bottom of the Edge curve (pos. 1.5.4/1.5.6).</p> <p>The small triangular glazing is positioned in the door frame top (pos 1.8)</p> <p>The Edge curve (pos. 1.5.4/1.5.6) is attached to the door frame using the connecting plate (V5), installed in step 4, and 2 self-tapping screws pan head 4,2 x 13 (S9).</p> <p>All fasteners should be hand tight.</p> <p>- See also step 4! -</p>
---	---

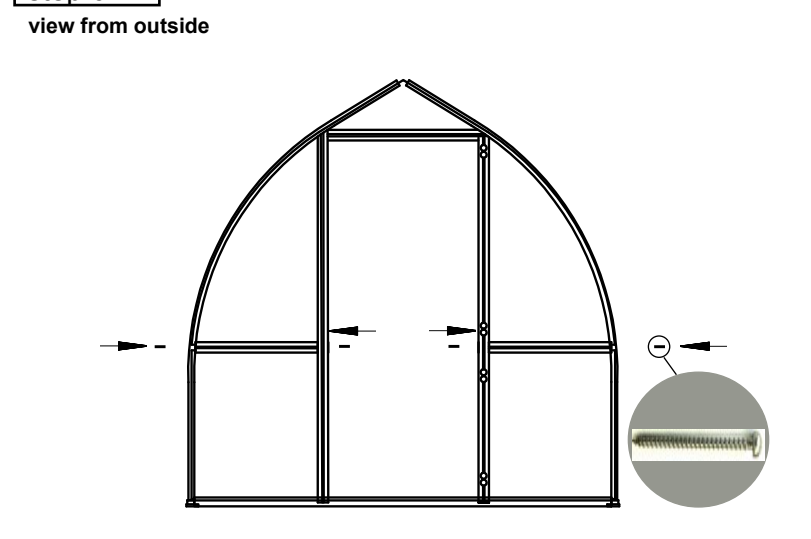
<p>step 6:</p> <p>view from outside</p> 	<p>to step 6:</p> <p>The cross bars (pos. 1.9) are mounted horizontally with the self-tapping pan head screw 4,8 x 45 (S13).</p>
---	---

The rear gable is assembled in the same way!!!

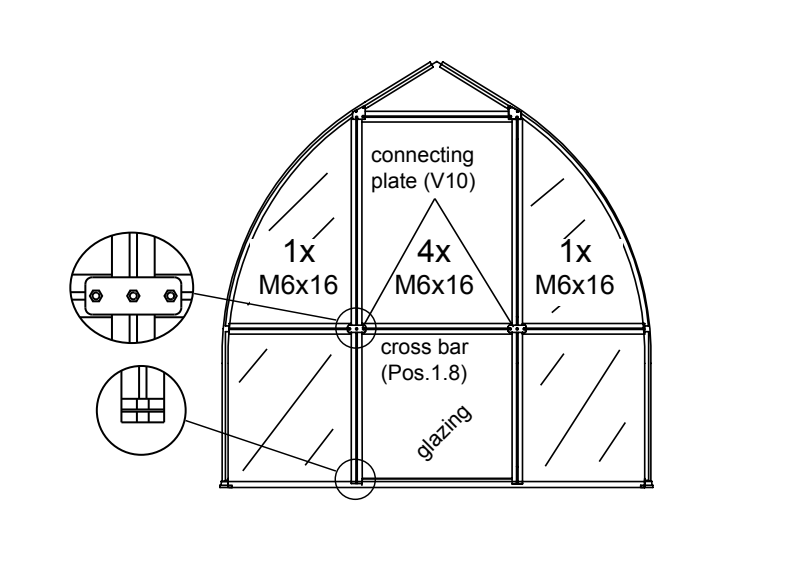
<p>step 7:</p> <p>Only rear gable!</p> 	<p>to step 7:</p> <p>Slide the upright profiles (pos 1.6/1.7) into the soil profile.</p> <p>Insert the (787 x 728 mm) glazing between the upright profiles (pos 1.6/1.7)</p> <p>Insert one M6 x 16 (S5) into each upright profile (pos 1.6/1.7)</p> <p>Insert two M6 x 16 (S5) into the cross bar (pos 1.8)</p> <p>Insert one M6 x 16 (S5) into each cross bar (pos 1.9)</p> <p>Connect the upright profiles (pos 1.6/1.7) to the cross bars (1.8/1.9) with connecting plates (V10)</p> <p>Attach the edge curve left/right (pos. 1.5.4/1.5.6) to the cross bars (1.9) with the self-tapping pan head screw 4,8 x 45 (S13).</p>
--	---



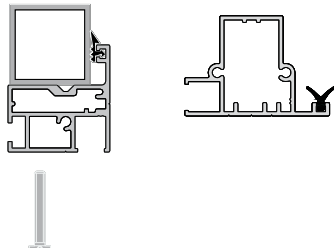
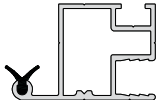
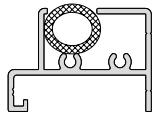

You should be careful:

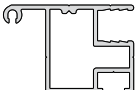
	<p>T-seal (V25) is for all doors and windows (total: 15 meters/49 feet)</p>	
	<p>Attention! The T-seal (V25) is only inserted on three sides of the roof window. The top side slides into the roof beam so no seal is required.</p>	<p>Attention! In the lower door press the seal into the profile first then install the rectangular tube.</p>
	<p>In the door threshold, the hose section (V14) is pressed into the soil profile. This prevents dirt from getting into the soil profile.</p>	

Profiles for roof windows (per roof window)

overview	pos.	description	number	length in mm
	4.1	roof window side profile	2	541
	4.2	roof window top/bottom profil	2	953

Content accessories bag roof window (per roof window)

overview	pos.	description/item number	number	length in mm
 *	V25	T-seal <small>item no 9999 0032</small>	2 1	641 1052
	V13	corner with grub screw, internal hex and flat point <small>item no 9999 0070</small>	4	
	V21	allen key <small>item no 9999 0056</small>	1	
	S12/ S1	hexagonal screw M6 x 12 nut M6 <small>item no 9999 0124 item no 9999 0128</small>	3	
	V24	corner bracket/roof window <small>item no 9999 0005</small>	4	

* **Note:** The seal is bundled in one strand for all doors and windows, please cut accordingly.

Assembly roof window

corner bracket/roof window (V24)

corner with grub screw (V13)

Top window profile (pos.4.2)
(This profile requires no T-seal)

Side window profile (pos. 4.1)

Side window profile (pos. 4.1)

Bottom window profile (pos. 4.2)

Attach the roof window side profiles to the bottom roof window profile using the corner brackets and the metal corners with grub screws.
Insert the roof window glazing into the side/bottom profiles you have assembled.
Attach the top roof window profile, tighten all grub screws and insert T seal on the three lower sides of the roof window.

Recommendation!

It is advisable to use silicon to seal where the polycarbonate enters the frame of the roof window. This will prevent rain from dripping into the greenhouse. See page 14 for details.

Attention: In the bottom cross profile insert two hex screws M6 x 12 (S12) for the window opener!



automatic roof window opener

Mounting roof window

wrong!!!

right

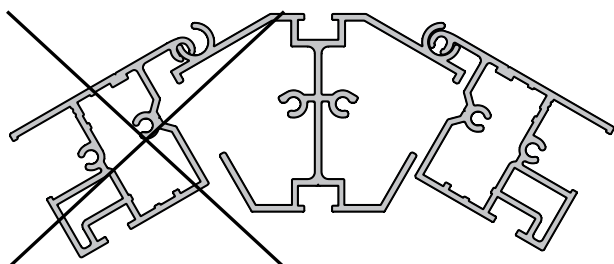

Please push the roof window from the gable end into the ridge profile and slide it into position.
Install the automatic opener mount into the crossbar.

Sealing the roof window area

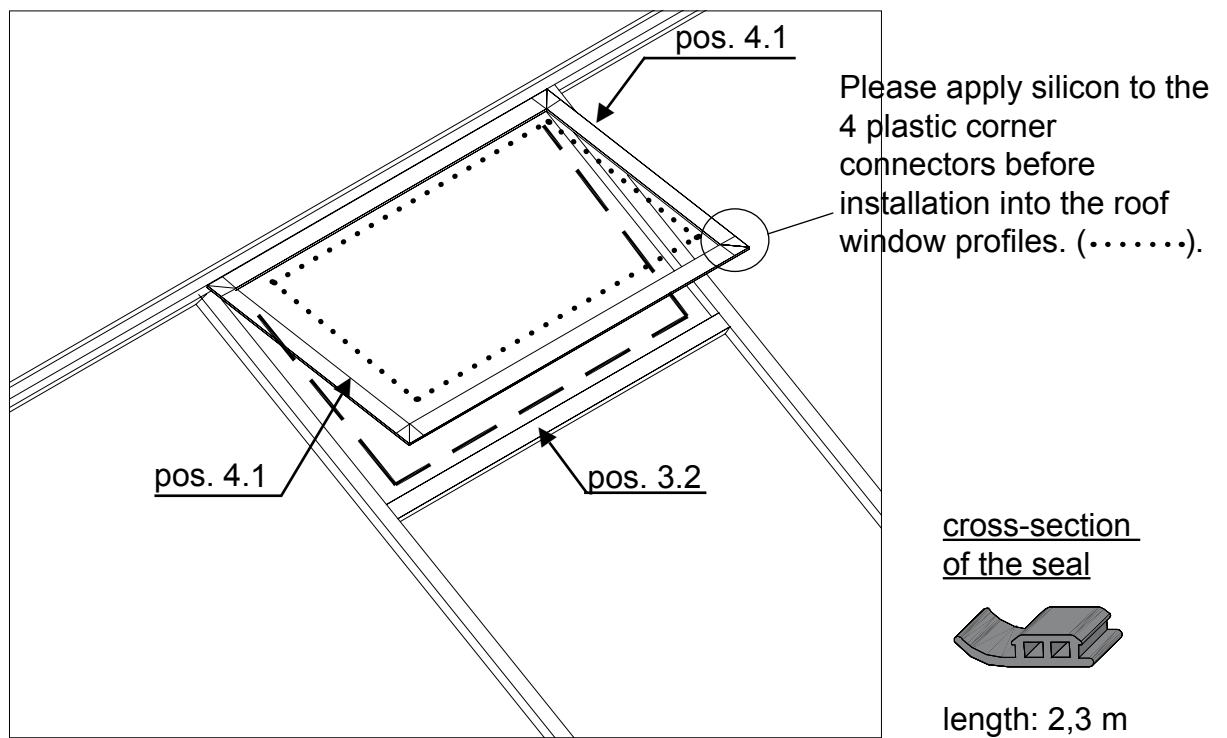

The seal is inserted as the sketch above. [.....]

Attention: Do not cut the seal in the corners! Important!

Please seal all connections of the roof window with silicon: Corner connector to side and bottom profile and glazing to side and bottom profiles. → see sketch.

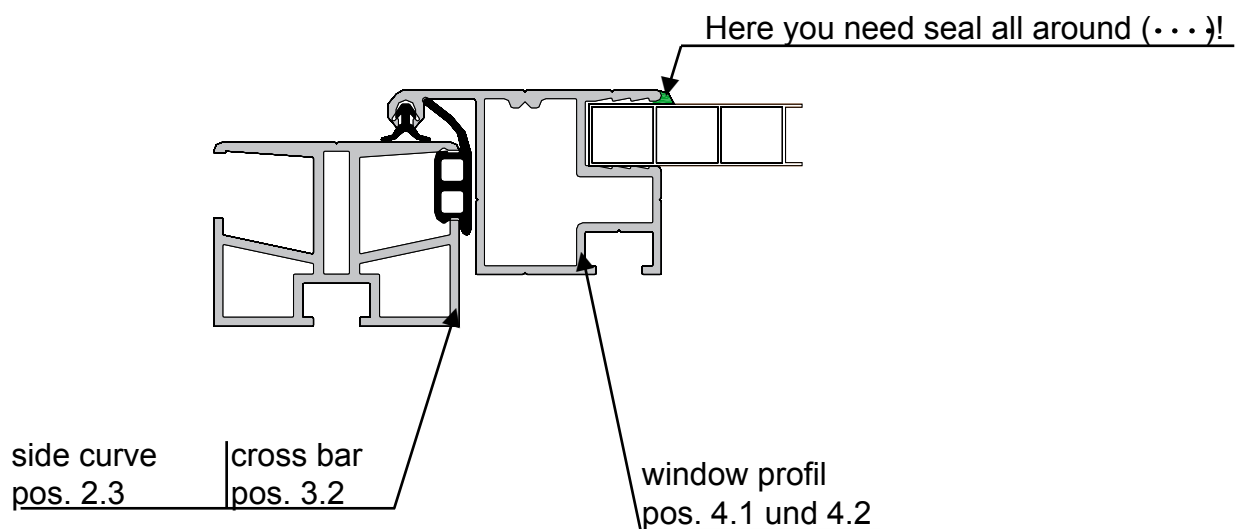

Automatic Window Opener

1	opener frame
2	pressure cylinder
3	cotter pin
4	mounting plate window profile
5	mounting plate cross bar

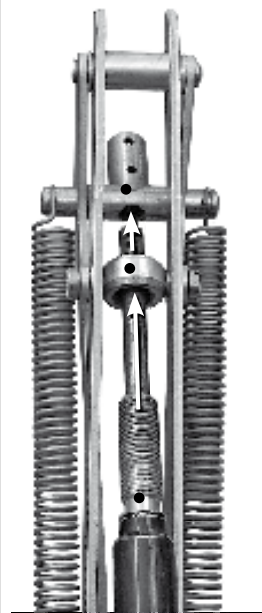
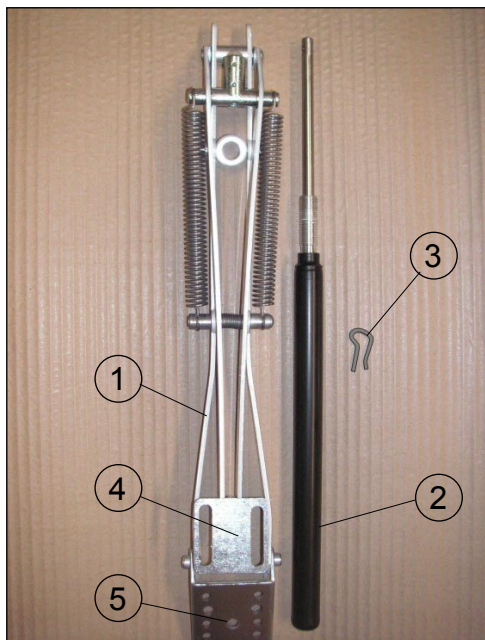
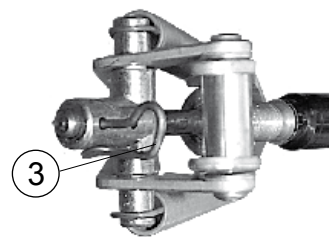

Auto Opener Installation

1. Check whether the greenhouse window can open and close freely and unhindered.
2. Install the window opener with the mounting plate (4) in the center of the lower roof window profile (pos 4.2)
3. Secure the cylinder by lining up the hole in the piston with the upper hole in the T-coupling, then insert the cotter pin.
4. Install the mounting plate (5) in the center of the cross bar(pos 3.2) using the middle hole in the mounting plate(5)
5. Attach the opener frame (1) to the mounting plate (5). Open the roof window until the threads of the piston (2) engage the threads of the opener frame (1). Thread the piston (2) half way into the threads in the opener frame (1).

Adjustment:

Let the opener acclimate to the greenhouse for 3-4 hours before you make adjustments.

For earlier engagement and a larger opening, turn the cylinder clockwise.

For a delayed engagement and a smaller opening turn the cylinder counter clockwise. Make sure you don't back it out too far.

For opening engagement advance/delay one full turn is about 1 degree Fahrenheit.

Please keep in mind that greenhouse temperatures can vary and windows can have different opening tolerances.



Winter-storage:

If the greenhouse interior does not stay above freezing we recommend you remove the cylinder from the window opener or remove the entire opener. Please store it in a dry frost-free place for the winter.





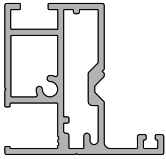

Required Maintenance:

Around springtime every year, check to make sure the piston shaft and cylinder threads are greased. Also check the piston shaft for ease of movement. A dab of marine grease on the piston shaft and the cylinder threads will be sufficient. Failure to do so could render your opener inoperable.

Profiles for divided revolving door - bottom -

overview	pos.	description		number	length in mm
	5.3.1	door profile botto		1	700
	5.6	door profile lef	with hole for sash lock	1	692
	5.7	door profile righ	with hinge hole	1	692
	5.9	door profile to	with transverse hole	1	700
	5.8	square tube	with transverse hole	1	740

Content accessories bag divided revolving door - bottom -

overview	pos.	description		number	length in mm
	V51	metal hinge, black	item no 9999 0358	2	
	V28	sash lock	item no 9999 0023	1	
	V29	QR-stopper 30 x 30 x 1,5-2	item no 9999 0099	2	
	V25	T-seal	item no 9999 0032	2 2	710 744
	S18	self-tapping screw countersunk head 4,8 x 25 (hinges)	item no 9999 0163	8	
	S17	self-tapping screw countersunk head 4,2 x 45 (doors)	item no 9999 0160	4	
	S19	self-tapping screw countersunk head 3,5 x 22 (sash lock)	item no 9999 0152	2	
	S6	pan head screw 3,5 x 38 (square tube)	item no 9999 0138	2	
	V32	glazing block 30 x 10 x 4		2	
	V30/ V31	corner bracket door profil	left - item no 9999 0009 right - item no 9999 0011	4	

* **Note:** The seal is bundled in one strand for all doors and windows, please cut accordingly.

Assembly - divided revolving door - bottom -

view from outside



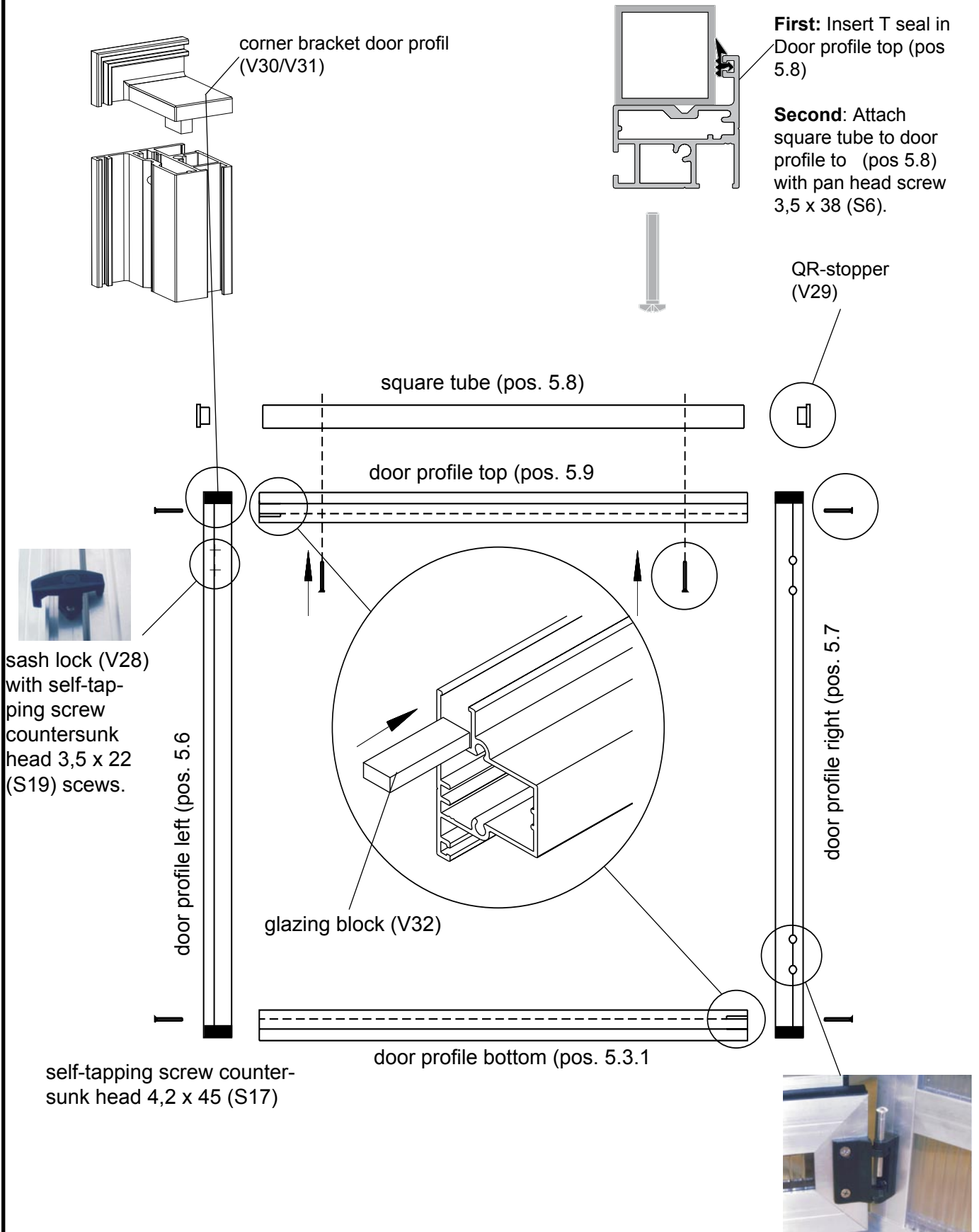



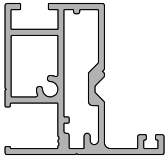
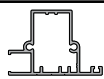



Lay the profiles out like the diagram below (possibly on cardboard or something similar).



Profiles for divided revolving door - top -

overview	pos.	description	number/length in mm	
			Riga S	Riga
	5.1	door profile lef	1 1081	1 1264
	5.2	door profile righ with hinge hole	1 1081	1 1264
	5.3	door profile to	1 700	1 700
	5.4.1	cross bar with hole for lockable door handle	1 700	1 700

Content accessories bag - divided revolving door - top

overview	pos.	description	number/length in mm	
			Riga S	Riga
	V52	door handle, lockable outside - item no 9999 0035 inside - item no 9999 0244	1	1
	S17	self-tapping screw countersunk head 4,2 x 45 (door) item no 9999 0160	6	6
	V32	glazing block 30 x 10 x 4	2	2
	V25	T-seal item no 9999 0032	2 710	2 710
			2 1112	2 1295
	V51	metal hinge, black item no 9999 0358	2	2
	S18	self-tapping screw countersunk head 4,8 x 25 (hinge) item no 9999 0163	8	8
	V28	sash lock, small item no 9999 0023	1	1
	S19	self-tapping screw countersunk head 3,5 x 22 (sash lock) item no 9999 0152	2	2
	V33	door locking device item no 9999 0230	1	1
	S22	wing-type self drill, screw counters head 3,5 x 13 (door stop) item no 9999 0189	1	1
	V30/ V31	corner bracket door profil left - item no 9999 0009 right - item no 9999 0011	2	2

* **Note:** The seal is bundled in one strand or all doors and windows, please cut accordingly.

Assembly - divided revolving door - top -

view from outside

Place the profiles on the ground or a flat surface like the diagram below (possibly on cardboard or something similar).

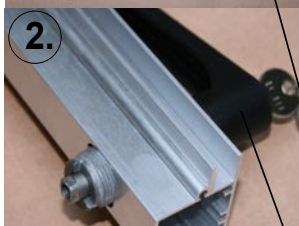
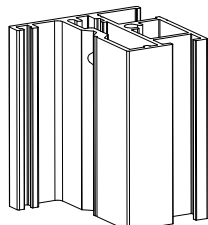
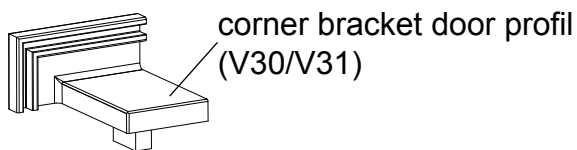

Assembly of door handle

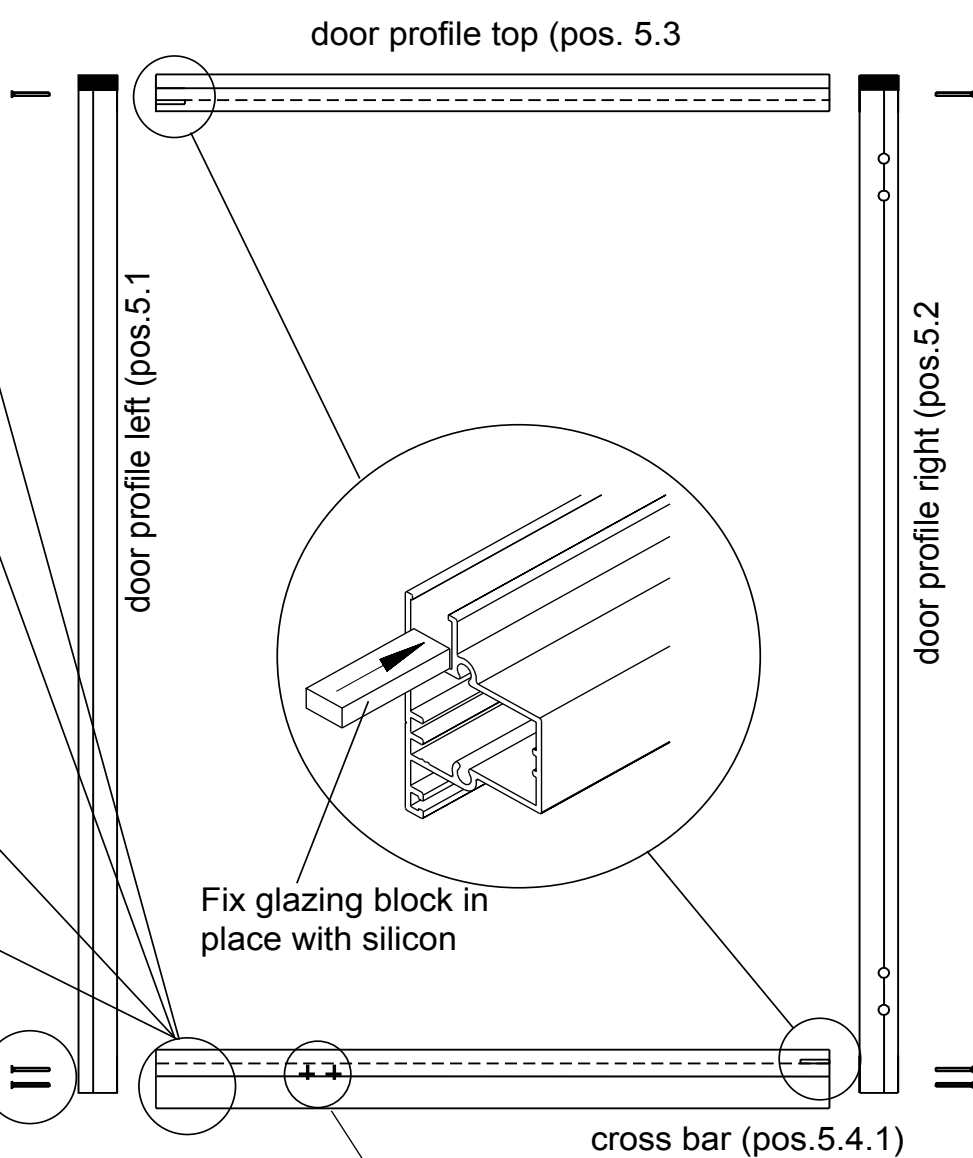



self-tapping screw countersunk head 4,2 x 45 (S17)

sash lock (V28) with self-tapping screw countersunk head 3,5 x 22 (S19) screws

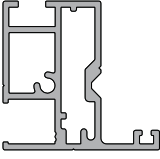

* **Note:** The seal is bundled in one strand for all doors and windows, please cut accordingly.

Profiles for rear window

overview	pos.	description		number/length in mm	
				Riga S	Riga
	5.1.2	door profile left	with hole for sash lock	1 1081	1 1264
	5.2	door profile right	with hinge hole	1 1081	1 1264
	5.3.1	door profile top		1 700	1 700
	5.4.2	door profile bottom	with hole for window opener	1 700	1 700

Content accessories bag - rear window -

overview	pos.	description	number/length in mm	
			Riga S	Riga
	S17	self-tapping screw countersunk head 4,2 x 45 (window) item no 9999 0160	6	6
	V32	glazing block 30 x 10 x 4	2	2
	V25	T-seal item no 9999 0032	2 710	2 710
			2 1112	2 1295
	V51	metal hinge, black item no 9999 0358	2	2
	S18	self-tapping screw countersunk head 4,8 x 25 (hinges) item no 9999 0163	10	10
	V28	sash lock, small item no 9999 0023	1	1
	S19	self-tapping screw countersunk head 3,5 x 22 (sash lock) item no 9999 0152	2	2
	V85	opener for rear window item no 9999 0303	1	1
	V145	corner (fixation of window) item no 9999 0416	1	1
	S9	self-tapping screw pan head 4,2 x 13 item no 9999 0144	2	2
	V30/ V31	corner bracket door profil left - item no 9999 0009 right - item no 9999 0011	2	2
	S12/ S1	hexagonal screw M6 x 12 with nut M6 item no 9999 0124 item no 9999 0128	4	4

* **Note:** The seal is bundled in one strand for all doors and windows, please cut accordingly.

Assembly - rear window -

view from outside

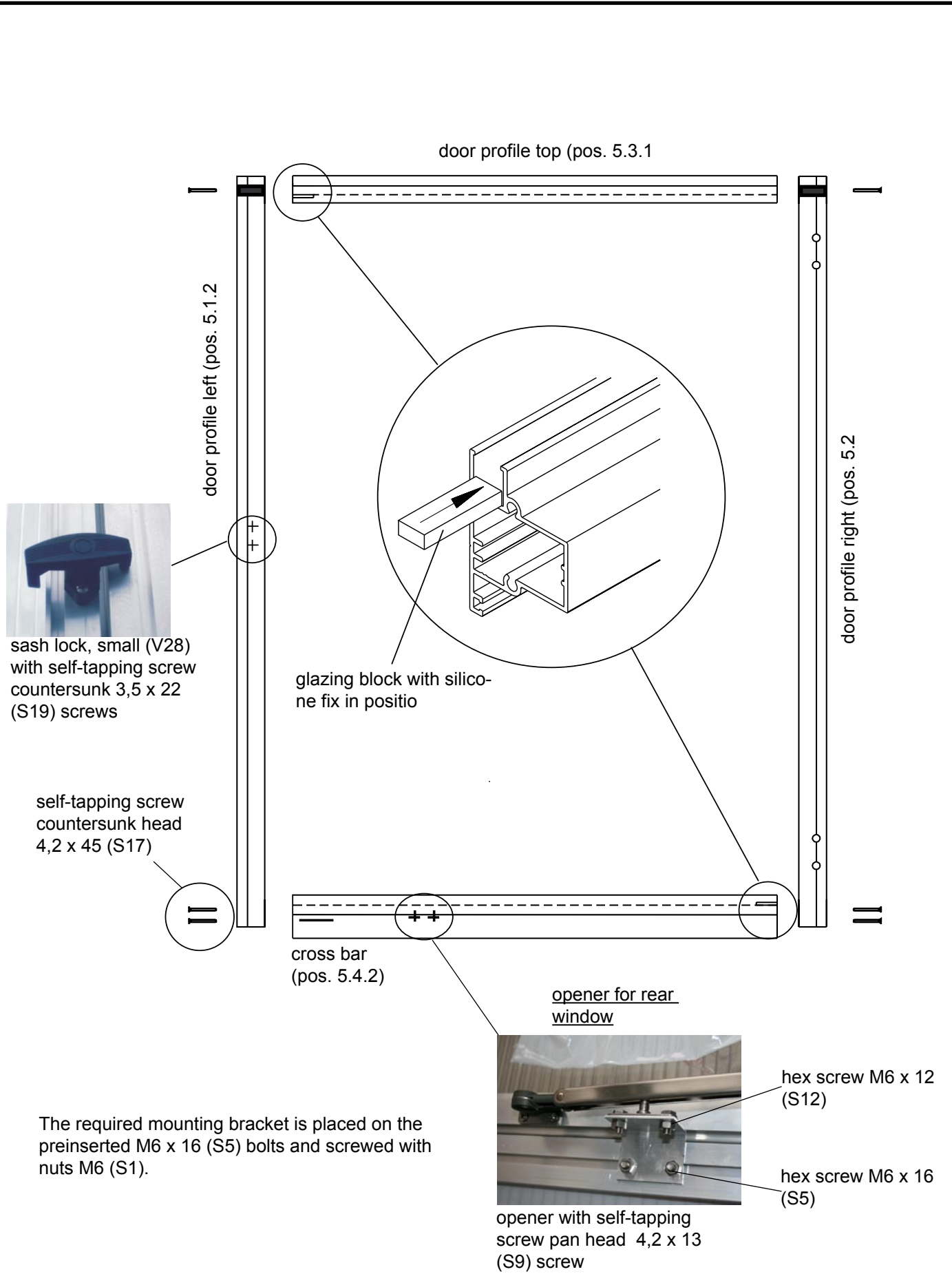

* **Note:** The seal is bundled in one strand for all doors and windows, please cut accordingly.

Installation of Door Catch

Door Catch Placement Riga Model IIs, IIIs, IVs

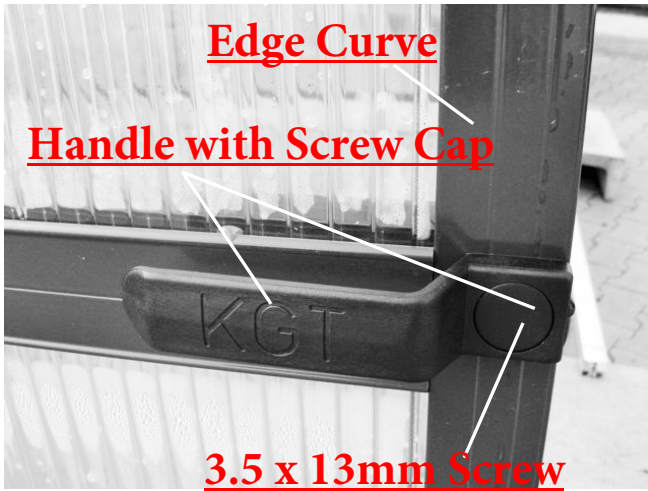

Door Catch Placement Riga Model III, IV, V

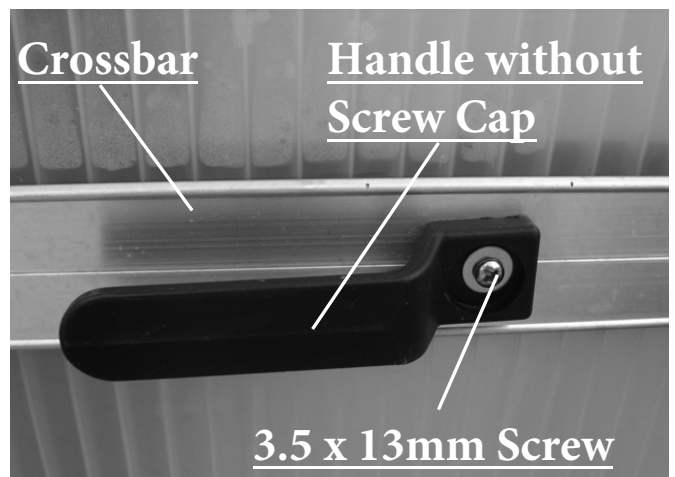
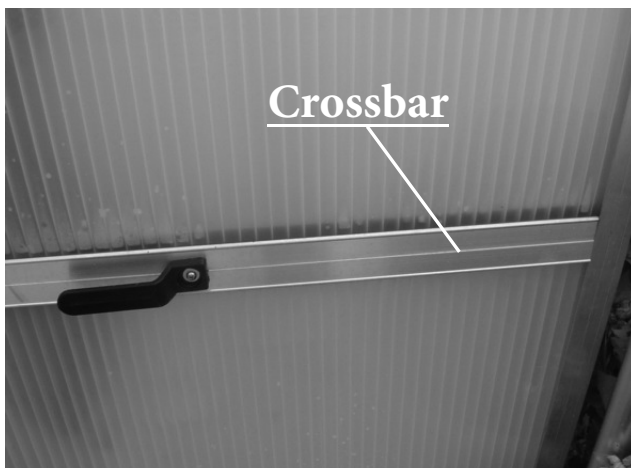

Assembly procedure - eaves -

ATTENTION! When using a foundation frame attach it to the soil profile before these steps (see pages 5, 6)

step 8

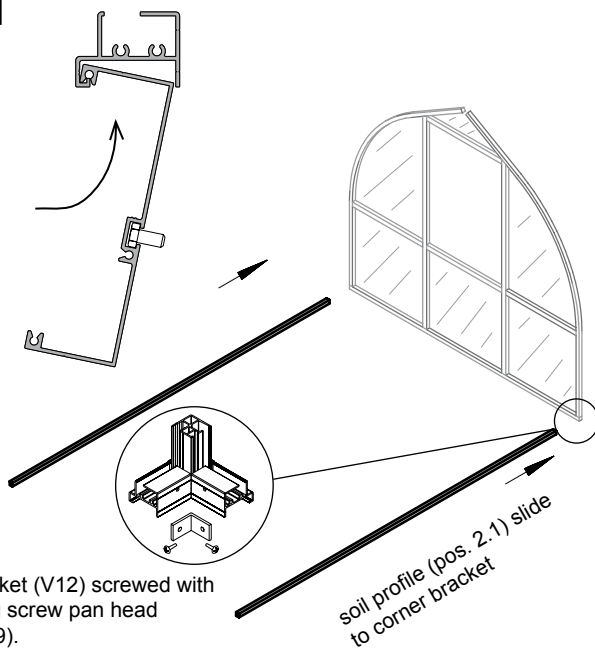

to step 8:

Note: If you have purchased a foundation frame attach it to the soil profiles before you attempt this step.

First attach the soil profiles(pos 2.1) to the end gables with the preinstalled corner connectors(V9).

Next screw the corner bracket (V12) to the gable end soil profile and the side soil profile. This will secure the gable end to the side wall.

step 9

ridge profile (pos. 3.3) at the gable and end plate (V11) screw with self-tapping screw pan head 4,2 x 13 (S9)

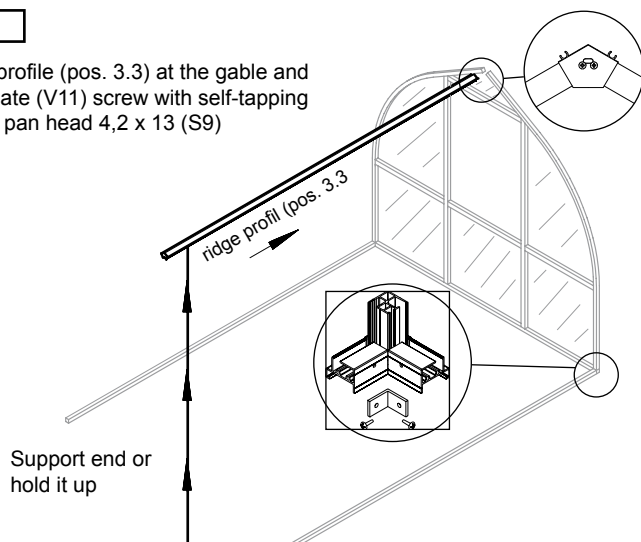

to step 9:

Some assistance will be needed for the following steps.

We recommend you have someone stand on a ladder and hold one end of the ridge profile while you proceed with the rest of the assembly. You could also construct a support to hold it in place.

Slide the unsupported end of the ridge profile into the grooves/slots in the top of the gable end. The top portion of the ridge profile should be flush with the outside of the gable end. Now attach the end plate(V11) with pan head screws 4.2 x 13 (S9)

step 10

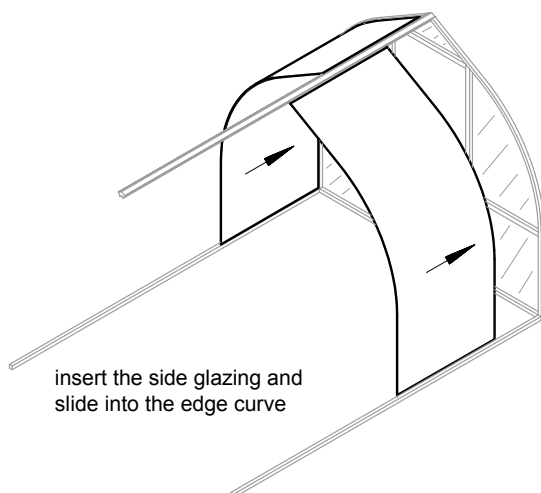

to step 10:

Insert the glazing in the ridge beam and the soil profile. Then slide it into the Edge Curve.

Tip:

Peel back the protective film on the glazing only around the edges. This will prevent the panels from getting scratched.

It is also a good idea to attach a stabilization angle (pos 3.4) to each of the side curves as you go along. This will help hold everything together.

Assembly procedure - eaves -

ATTENTION! When using a foundation frame assemble in advance on this soil profile (see pag s 5,

step 11

shown enlarged
side curve (pos. 2.3)

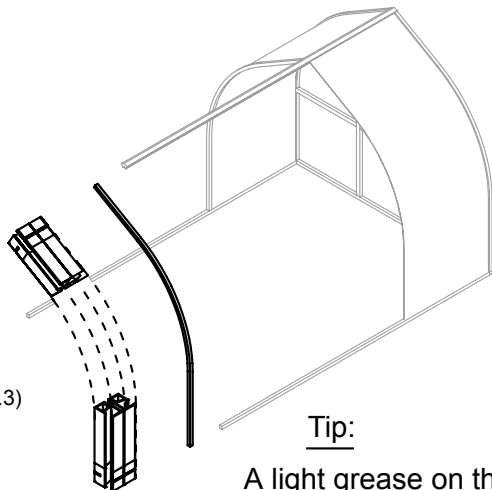

Tip:
A light grease on the plastic sliders may help movement.

to step 11:

First place a side curve up against the edge curve installed on the gable end. You want to match curvature of the edge curve with the side curve. This will ensure that the side curve is installed in the correct direction.

Slide the side curve (pos 2.3) into the ridge profile and into the soil profile. Work it down until it is flush with the glazing then work the glazing into it.

If necessary you can use a rubber mallet on the side curve to move it down. Be careful not to damage the aluminum.

step 12

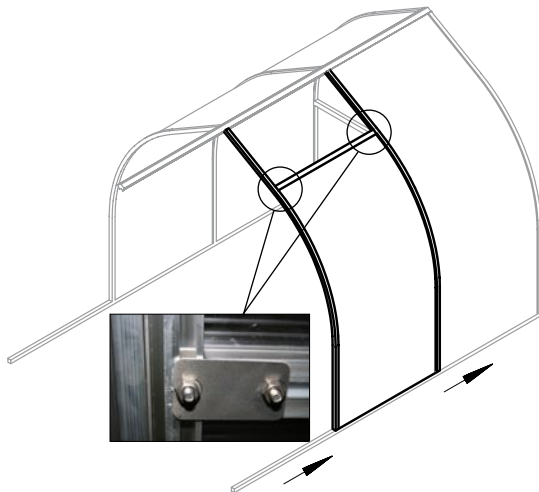

to step 12:

Continue inserting the side glazing and side curves.

The connecting plate (V4) is attached from the inside with screw hex M6 x 16 and nut M6. This secures the window crossbar to the greenhouse.

step 13

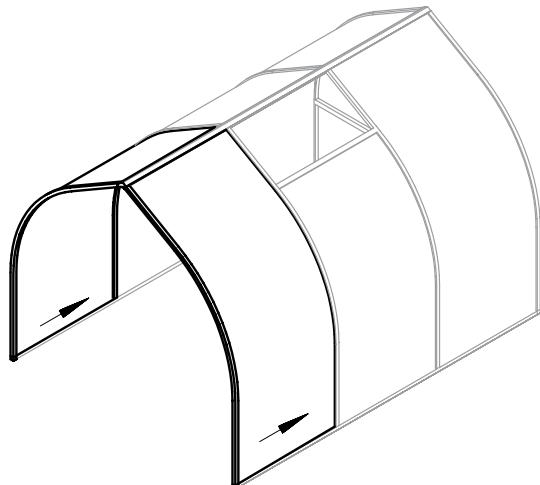

to step 13:

Insert the remaining glazing panels and side curves.

Assembly procedure -eaves-

ATTENTION! When using a foundation frame attach it to soil profile in advance (see pages 5, 6)

step 14

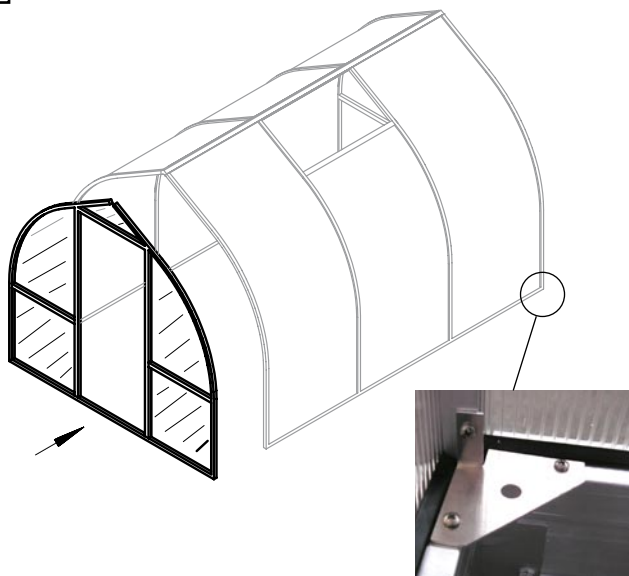

to step 14:

Attach the preassembled door gable.
Refer to steps 8-9 for attachment procedures.

For added stability install the inside corner (V1). Use the self-tapping screw pan head 4,2 x 13 (S9).

step 15

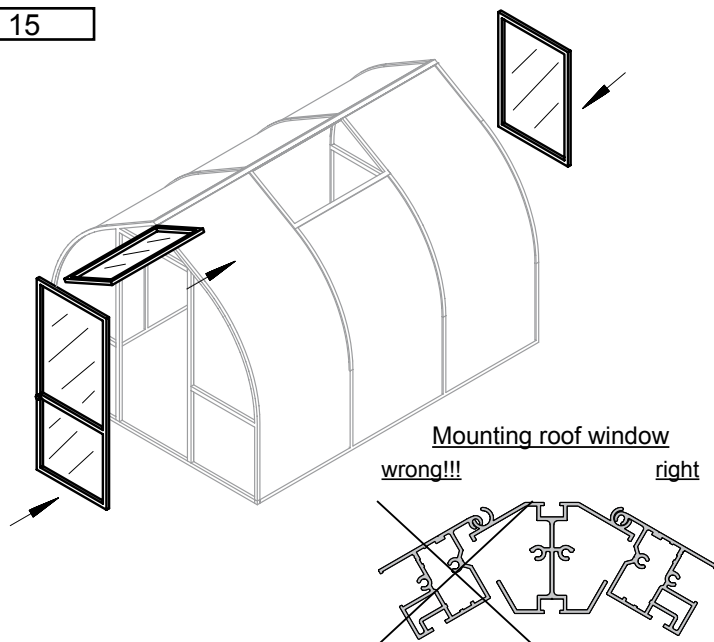

to step 15:

Install the door and windows.
Instructions, see page 12-21.

step 16

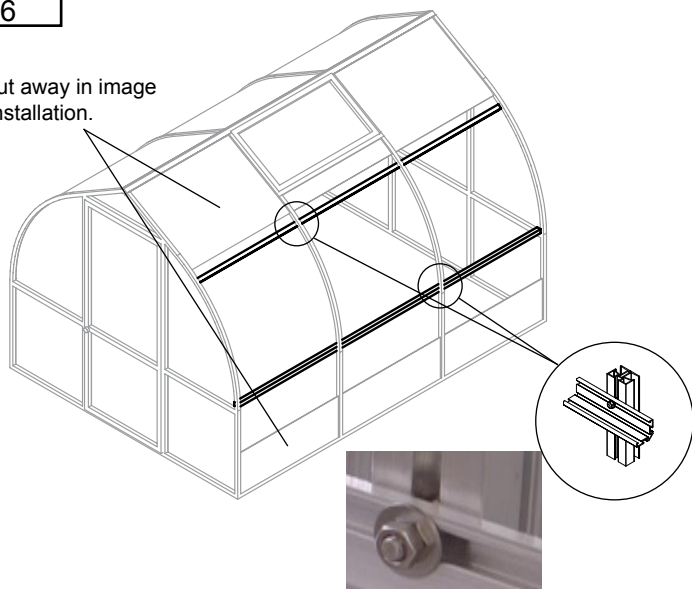

Glazing cut away in image to show installation.



to step 16:

The stabilization angle (pos 3.4) is installed on both sides from inside. It is attached to the side curve with screw M6 x 16, nut M6 and washer A6, 4 screwed.
The stabilization angles (pos 3.4) are also the rear supports for the top and bottom shelf (see separate instructions).

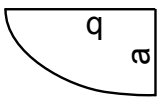
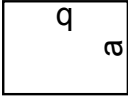
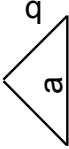
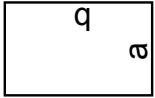
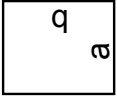
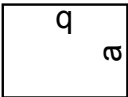
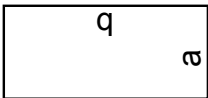
Polycarbonate Glazing Size Sheet

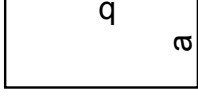
type of house	gable above	gable below	gable triangular	door/window	div. revol. door/bottom	rear gable below	side glazing	roof window	below roof window
									
	number size (a x b)	number size (a x b)	number size (a x b)	number size (a x b)	number size (a x b)	number size (a x b)	number size (a x b)	number size (a x b)	number size (a x b)
Riga II S	4 730 x 1135	4 730 x 728	2 779 x 239	2 724 x 1031	1 724 x 676	1 787 x 728	3 1048 x 2634	1 974 x 565	1 1048 x 1984
Riga III S	4 730 x 1135	4 730 x 728	2 779 x 239	2 724 x 1031	1 724 x 676	1 787 x 728	5 1048 x 2634	1 974 x 565	1 1048 x 1984
Riga IV S	4 730 x 1135	4 730 x 728	2 779 x 239	2 724 x 1031	1 724 x 676	1 787 x 728	6 1048 x 2634	2 974 x 565	2 1048 x 1984
Riga III	4 1048 x 1319	4 1048 x 728	2 779 x 239	2 724 x 1215	1 724 x 676	1 787 x 728	5 1048 x 3000	1 974 x 565	1 1048 x 2345
Riga IV	4 1048 x 1319	4 1048 x 728	2 779 x 239	2 724 x 1215	1 724 x 676	1 787 x 728	6 1048 x 3000	2 974 x 565	2 1048 x 2345
Riga V	4 1048 x 1319	4 1048 x 728	2 779 x 239	2 724 x 1215	1 724 x 676	1 787 x 728	6 1048 x 3000	4 974 x 565	4 1048 x 2345